

11RS7 SERIES

TYPE: _____

- MADE IN USA
- MR-11 LAMP ADAPTOR
- LOW VOLTAGE
- MULTI TASK

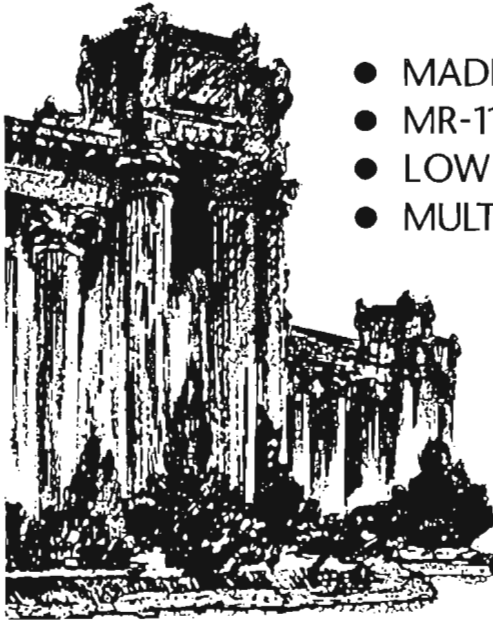

- LENS
- WITHOUT
- CLEAR-C FROSTED -F
- HONEYCOMB-HC COLOR _____
- FIXTURE COLOR
- BLACK WHITE CUSTOM

SPECIFICATION GUIDE: 11RS7BC

Designation:	Fixture Series	Fixture Color	Lens
Sample specification:	11RS7	B	C

DESCRIPTION EXAMPLE: ALEXANDRA SERIES 11RS7, black fixture with clear lens.

APPLICATIONS:

DISPLAYS: Showcases, show windows, counters, cabinets, soffits, perimeter fixtures, art objects.
ARCHITECTURAL: Soffits, perimeter lighting, cornices, and many more.

CAPACITY: 50W maximum.

COLOR: Black, white or custom.

CONSTRUCTION: Metal lamp ring and arm.

DIMENSIONS: 2-7/8" x 1-3/4"

FILTERS: Honeycomb louvers, clear, colored or frosted lenses available.

FUSING: Must fuse primary and secondary on the transformer.

LAMPS: MR-11, 12 or 24 volt, 20, 35 or 50 watt narrow, medium or wide beam. Not included and must be ordered separately.

LAMP SPACING: Maximum 2.25" on center.

MOUNTING METHOD: Snap onto Alexandra Series 77 or 78 light strip.

SAFETY LABEL: ETL listed - Class 1 #A02929140060

SPECIAL FLEXIBILITY FEATURE: Fixture rotates 360° in either direction and tilts 180°.

VOLTAGE: 12 or 24 volts.

WARRANTY: One year limited. Conditioned on the use of ALEXANDRA LIGHTING SYSTEMS INC. supplied transformers.

WATTAGE: 20, 35 OR 50 watt, 1MR-11 lamps.

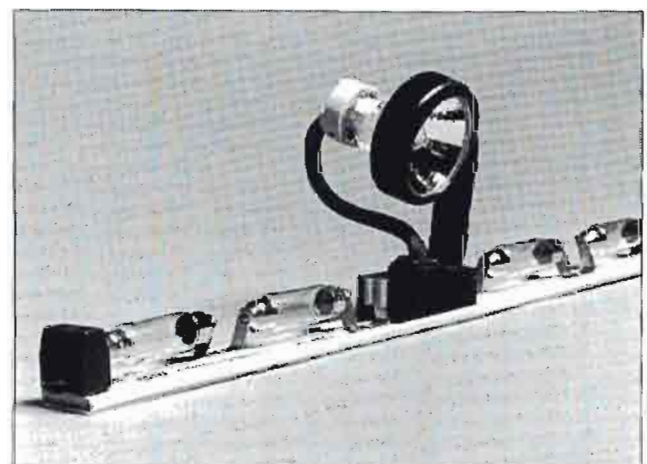

FILTER ACCESSORIES: Order separately. 1.25" diameter.

FILTERS: A-Color lens, B-frosted, C-honeycomb louver, D-clear. See reverse side for catalog numbers.

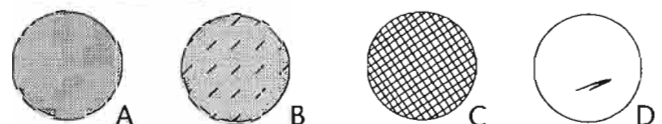



4311 MEADOW VIEW COURT • COLORADO SPRINGS, CO 80918 • TEL: 719-548-8805 • FAX: 719-260-7929

All product illustrations are based on current information at the time of publication. Alexandra Lighting Systems, Inc. reserves the right to make changes without notice or obligation in prices, specifications, colors and materials, and to change or discontinue models. Call for latest information. Part substitution voids all warranties. 1997 Alexandra Lighting Systems, Inc.

ALEXANDRA®

LIGHTING SYSTEMS, INC.
4311 MEADOW VIEW COURT
COLORADO SPRINGS, CO 80918
TEL: 719-548-8805 FAX: 719-260-7929

	Narrow Beam	Medium Beam	Narrow Beam	Medium Beam
				
	JRM12V 20W/2N/G4	JRM12V 20W/2M/G4	JRM12V 35W/2N/G4	JRM12V 35W/2M/G4
Volts (V)	12	12	12	12
Watts (W)	20	20	35	35
Base	GZ4 typical	GZ4 typical	GZ4 typical	GZ4 typical
Beam Angle (V° x H°)	10°x10°	16°x16°	10°x10°	16°x16°
Color Temperature (°K)	3000	3000	3000	3000
Average Life (hrs)	2000	2000	2000	2000

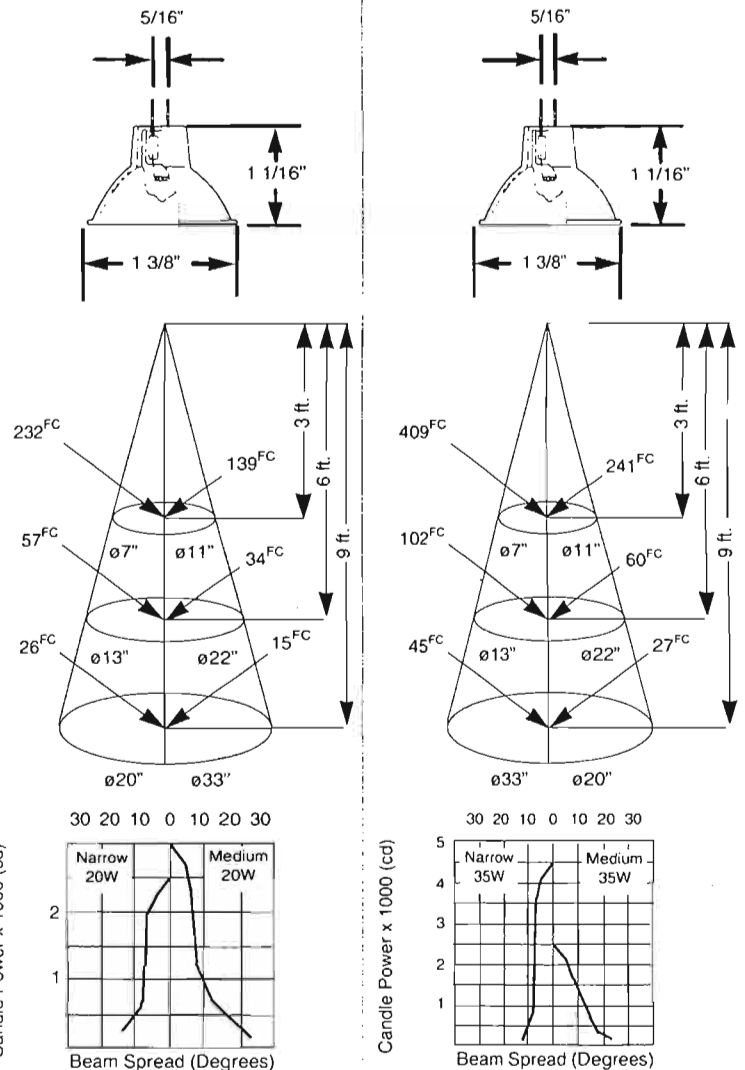
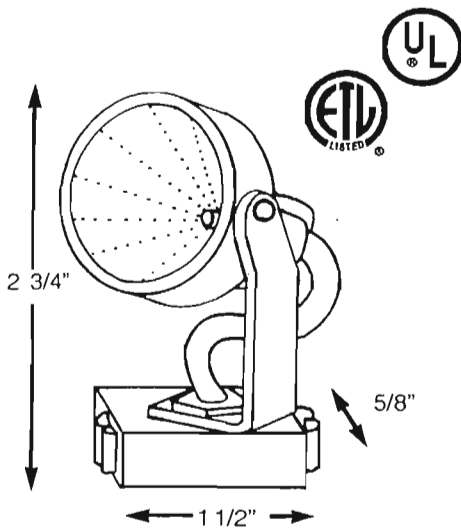

LENS ACCESSORIES FOR MR-11

CATALOG #	DIAMETER	DESCRIPTION
LS11HC	1.25"	HONEYCOMB
LS11C	1.25"	CLEAR
LS11F	1.25"	FROSTED
LS11B	1.25"	BLUE
LS11R	1.25"	RED
LS11P	1.25"	PINK

*Lamp life is based on average lamps as tested. Actual Lamp life, kelvin or lumen may vary in actual usage.